

Chlorophyll Fluorescence: What Is It and What Do the Numbers Mean?

Gary A. Ritchie

Gary A. Ritchie is Consultant in Environmental and Forest Sciences, 8026 61st Ave. NE, Olympia, WA 98516; telephone: 360.456.3438; e-mail: rosedoctor@comcast.net

In: Riley, L. E.; Dumroese, R. K.; Landis, T. D., tech. coords. 2006. National Proceedings: Forest and Conservation Nursery Associations—2005. Proc. RMRS-P-43. Fort Collins, CO: U.S. Department of Agriculture, Forest Service, Rocky Mountain Research Station. 160 p. Available at: <http://www.rngr.net/nurseries/publications/proceedings>

Abstract: Although results of chlorophyll fluorescence (CF) measurements in nursery seedlings are becoming widely reported in the literature, the theory, terminology, and interpretation of these data are often obscure and confusing to nursery practitioners. This report outlines the underlying physiological basis for chlorophyll fluorometry and discusses measurement protocols and equipment. Interpretations of CF emissions are elucidated using heretofore unpublished data derived from Douglas-fir nursery seedlings.

Keywords: seedling physiology, stress physiology, Photosystem I, Photosystem II

Introduction

Optimum seedling physiological quality is central to achieving successful regeneration, vigorous first-year height growth, and green-up requirements. Seedling testing is an important tool for assuring that high quality seedlings are consistently delivered for field planting (Tanaka and others 1997). However, seedling testing is expensive and time-consuming.

For many years researchers have sought a “quick test” of seedling viability—a test that could be performed rapidly and easily immediately following a stress event—that would quantitatively indicate the level of damage that the plant had sustained and would predict subsequent plant performance. One emerging technology that has been developed in an effort to achieve this goal is called chlorophyll fluorescence (CF).

CF offers promise because it probes the inner mechanisms of the light reaction of photosynthesis, which is highly sensitive to stress (Krause and Weis 1991). As plants are subjected to various types of stresses (for example, cold damage, nutrient deficiency, disease), these can be detected, and sometimes diagnosed, by analysis of the fluorescence emissions emanating from chlorophyll_a (Chl_a) in Photosystem II (PSII) of the light reaction (for example, Strand and Öquist 1988; Adams and Perkins 1993; Mohammed and others 1995 and references contained therein). Furthermore, CF analysis is rapid, nondestructive, and objective.

Although these techniques were developed in the 1930s (Govindje 1995), they have not been used in nursery seedling physiology research until recently because of the high cost and low portability of the instrumentation required. The advent of microprocessors, miniaturization, and advanced battery technology, however, has led to development of relatively low-cost, portable fluorometers capable of carrying out highly sophisticated field measurements.

Objectives

Unfortunately, CF terminology is confusing and often obscure to nursery practitioners. Yet the nursery literature contains a growing number of papers that report on the results of CF research as it applies to forest tree seedlings and regeneration. In recognition of this situation, this report has two objectives: 1) lay out a conceptual format that will enable nursery personnel to understand the physiological basis for the measurement of CF; and 2) provide baseline seasonal and diurnal profiles of several key CF parameters for “normal” Douglas-fir (*Pseudotsuga menziesii*) nursery seedlings that can be used to interpret CF information and literature reports.

The Physiological Basis of Chlorophyll Fluorescence

When radiant energy from the sun strikes a leaf, a portion of it is reflected, some is transmitted through the leaf, and the remainder is absorbed by the leaf. To avoid damage, the leaf must dissipate, or use up, all of this absorbed energy in some

manner. This process is called energy “quenching.” Three competing types of quenching are recognized. The first type is called photochemical quenching (qP) in which the light energy is converted to chemical energy that is used later to drive photosynthesis. Because the plant’s light requirement for photosynthesis is often small relative to the absorbed light, much of this extra energy is dissipated as heat. This is called nonphotochemical quenching (qN). Finally, a small but important portion of the excess energy is given off as fluorescence emissions from chlorophyll molecules. This is called fluorescence quenching (qF).

Sometimes, under high light conditions, the plant may be unable to quench all the energy it absorbs. When this occurs, the excess energy fuels biochemical reactions that generate free radicals such as peroxides and other toxic oxygen species. The plant manufactures antioxidants to mop up these free radicals and render them harmless. However, these free radical scavenging systems can become overwhelmed, in which case the plant suffers from what is known as “photodamage” (Demig-Adams and Adams 2000). We sometimes see this in nursery crops. A good example would be greenhouse-grown hemlock (*Tsuga heterophylla*) stock that exhibits needle “scorching” following transplanting into a bareroot nursery.

Light energy enters the leaf of a plant and is “captured” by light harvesting pigments (figure 1). Depending on the wave length of the captured light, it enters one of two reaction centers called Photosystem I (PSI) and PSII, which are located on membranes in the chloroplasts. When a Chl_a molecule in PSII absorbs a photon of energy, one of its electrons is raised to a higher energy state. While in this state it is captured by an electron acceptor pool from which it funnels down through an electron transport chain into PSI, where a similar process occurs (PSI and PSII are named

in the order in which they were discovered, not the order of the reaction). In PSI, the photochemical process generates NADPH that provides the energy for turning CO_2 into sugar in what is known as the “Calvin Cycle.” In this manner, the light reaction converts absorbed light energy into stored chemical energy.

Another key part of the light reaction is called “water splitting.” In order to replenish the electrons that are lost from Chl_a in PSII, the plant splits water molecules, releasing oxygen atoms into the atmosphere and providing electrons that feed into PSII.

For any of a number of reasons, many of the excited electrons from Chl_a in PSII are not captured by the acceptor pool and they decay back to their ground state. The energy lost in this decay process is given off as fluorescent light (fluorescence quenching). This is shown in figure 1 as a wavy line. It is this emission of fluorescent light that is measured in chlorophyll fluorescence.

Measurement of Chlorophyll Fluorescence (CF)

Kautsky Fluorometers

Observations of chlorophyll fluorescence were first reported by Kautsky and Hirsch in 1931 (Govindje 1995). They acclimated plant cells to darkness for several minutes, clearing all the excited electrons from the electron transport chain and emptying the acceptor pools. Then they exposed the cells to a brief pulse of high intensity photosynthetically active light and monitored the rise and fall of the ensuing fluorescence emission with a sensitive photometer. What they observed was similar to the curve in figure 2. These

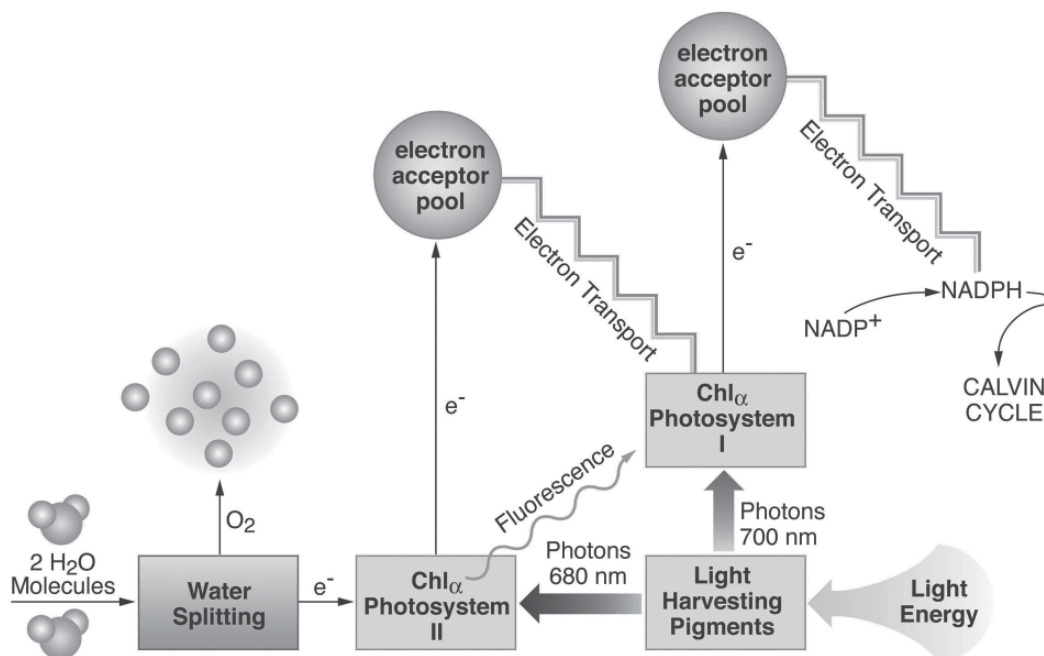

Figure 1—Simplified diagram of the “light reaction” of photosynthesis. Chlorophyll fluorescence emanates from chlorophyll_a in Photosystem II.

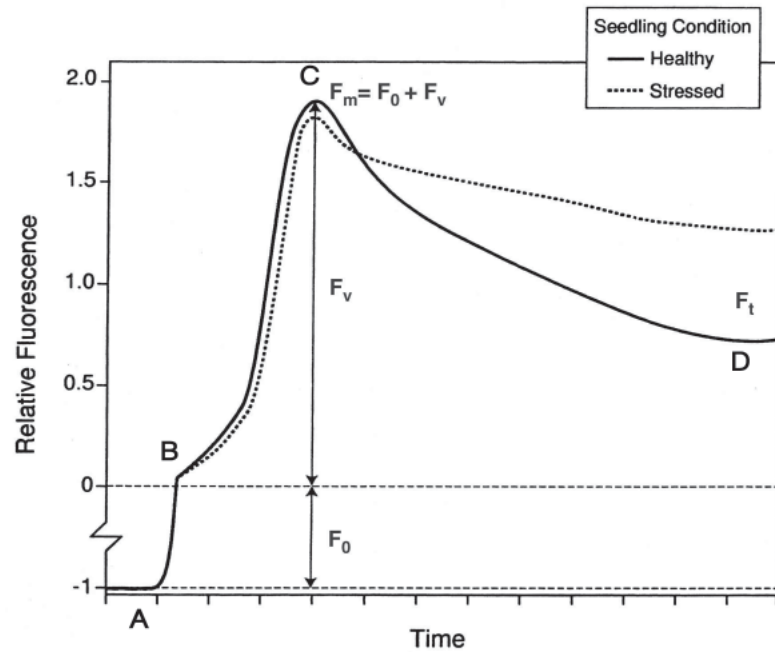

Figure 2—A typical chlorophyll emission curve for a leaf made with a “Kautsky” fluorometer. A is at the point of the actinic light pulse; B is the chlorophyll emission when all reaction centers are open; C is the emission peak; and D is the emission approaching steady state. F_0 is the fluorescence emanating from the light harvesting complex. F_m is maximum fluorescence. F_v , variable fluorescence = $F_m - F_0$. F_t is steady state fluorescence. If the leaf is under significant stress, say from cold damage, the emission curve may resemble the upper dotted line.

observations led to the development of what are now known as “Kautsky” fluorometers, which generate similar curves to that in figure 2.

In a “Kautsky curve” (figure 2), emissions rise to a point, F_0 , which represents fluorescence where all reaction centers are open and qP is maximal. Then, there is a sharp rise to a point of maximum fluorescence (F_m). The rise from F_0 to F_m is called “variable fluorescence,” or F_v . F_m is transient, giving way rapidly to a marked decrease, then a gradual decay to the steady state, F_t . Note that when the plant is under significant stress, the emission peak continues unabated for a long period of time. This is evidence that healthy cells are able to “quench” light energy while killed or damaged cells are not.

A key observation was made by Genty and others (1989). They showed that the ratio of F_v/F_m is a direct measure of the “optimal quantum efficiency” of the plant. This is a very important plant property that indicates how efficient the light reaction is proceeding. It has a theoretical maximum value of about 0.83. Many studies using Kautsky-type fluorometers report primarily this value as the results of their analysis (for example, Fisker and others 1995; Binder and Fielder 1996; Perks and others 2001; Perks and others 2004).

Pulse Amplitude Modulated (PAM) Fluorometers

During the 1980s, workers in Germany developed a novel fluorometer called a pulse amplitude modulated (PAM) fluorometer (Schreiber and others 1995). With this instrument, the initial light pulse is followed by a series of rapid pulses of very high intensity saturating light (up to 6,000 $\mu\text{mol}/\text{m}^2/\text{s}$) that overwhelm the acceptor pools, thus canceling out qP. The fluorescence emission difference between these peaks and the fluorescence decay curve is, therefore,

qN. This is often called a “quenching analysis” because it provides separate estimates of the three components of quenching. It turns out that this type of analysis is a powerful tool for evaluating plant stresses. In theory, qP represents the more “desirable” form of quenching in which light energy is converted to chemical energy (figure 1). In contrast, qN can be thought of as “back up” quenching, or venting off of excess energy with no gain to the plant. While plants generally rely on both qP and qN to dissipate energy, as they come under stress, qP tends to remain relatively constant while qN tends to increase. We will see examples of this later.

Equipment—Fluorometers of both types (Kautsky and PAM) contain similar components. These include a light source, two filters, a photo sensor, and a fiber optic cable with an attached leaf clip (figure 3). The unit interfaces with a laptop computer. Prior to measurement, the subject leaf is darkened for 20 to 30 minutes. The leaf clip is attached to the leaf, then the light source gives off a strong pulse that travels first through a filter that passes photosynthetically active radiation, then through the cable to the leaf. Fluorescent light emitted by the leaf passes back through the cable, through the second filter to the photo detector, which measures its intensity for approximately 5 minutes. This is then recorded and calculations of CF parameters are made by the computer. From this analysis Kautsky fluorometers yield the values shown in appendix 1A; PAM fluorometers yield these same values plus those shown in appendix 1B. Note that Kautsky fluorometers are not capable of estimating quenching coefficients, which greatly limits their usefulness.

“Normal Values” of CF Parameters

Discussions with other scientists, notably Mohammed (2005), as well as perusal of the CF literature led to the development of table 1. This gives what are often considered

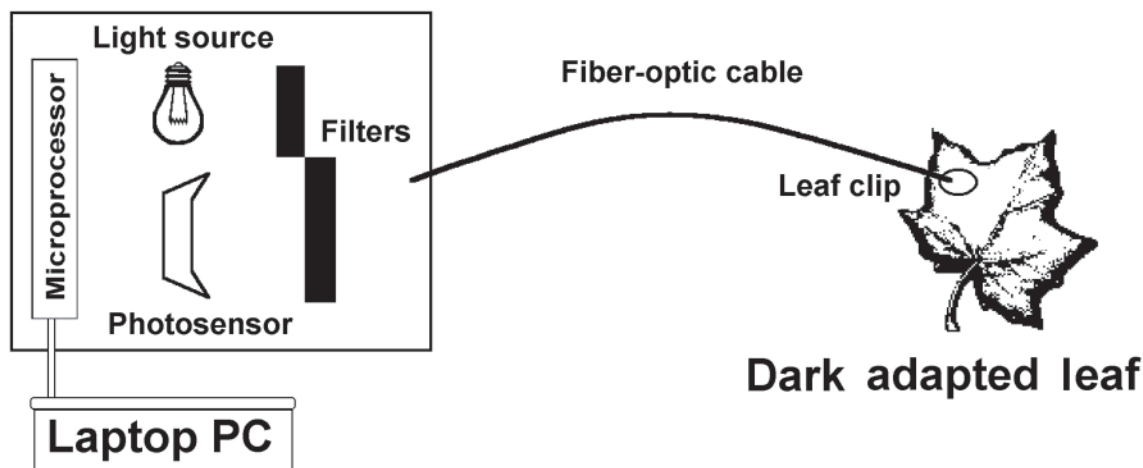

Figure 3—Diagram of a typical chlorophyll fluorometer. An actinic light pulse generated by the light source travels to a dark adapted leaf through a fiber optic cable. Fluorescence emissions from the leaf return through the cable to the photosensor. The emission curve and emissions parameters are generated by the microprocessor. The instrument interfaces with a laptop PC.

Table 1—“Normal values” of CF emissions parameters in plants extracted from the literature and Mohammed (2005). See appendix for parameter definitions.

Parameter	“Normal” value	“Stress” value
F_o	0.2 to 0.4	>0.7 indicates low absorption in chlorophyll antenna bed due to chlorophyll breakdown or reconfiguration
F_m	1.2 to 1.5	
F_t	$F_t \sim F_o$	low F_t
F_v/F_m	Approximately 0.700 to 0.830	<6.0
Y	0.40 to 0.60	0.1 to 0.2
qN	0.4 to 0.6	prolonged values > 6.0
qP	0.7 to 0.8	prolonged values < 6.0
ETR (in full sun)	<300 electrons $\mu\text{mol}/\text{m}^2/\text{s}$	

to be “normal” values for the CF parameters shown in appendix 1. These, then, will be used as a template against which to compare the Douglas-fir values reported below.

CF Emissions From Healthy Douglas-Fir Nursery Seedlings

In spring 1997, we transplanted 1+0 Douglas-fir seedlings directly from freezer storage into a nursery in western Washington where they were grown as an operational crop. We monitored CF emissions from these seedlings on a regular basis through a 1-year growing cycle using a PAM fluorometer. Temperature and light conditions were also recorded during the measurement period.

Fluorescence Emissions Immediately Following Transplanting

The first thing we noted was that seedlings recovered from freezer storage quite rapidly. F_o , F_m , and F_v/F_m stabilized within 3 days (figure 4). At the time of planting, F_o ranged from 0.2 to 0.4, which is considered to be normal for most

plants (table 1), while F_m began low but immediately climbed to within its normal range (approximately 1.2 to 1.5) and remained there. F_v/F_m began at about 0.60, but climbed to nearly 0.80 within 1 day and remained there. An F_v/F_m value of 0.60 is relatively low (remember the optimum is 0.83), but probably not low enough to indicate a significant stress.

The quenching coefficient qP remained within a range of about 0.7 to 0.8 throughout the period (figure 5). In contrast, qN began at a very low value and increased sharply 2 days after planting to briefly exceed qP. It then decreased gradually until, approximately 2 weeks later, it reached steady state at about 0.5, which is within the normal range. This suggests that some enzyme(s) required for one of the qN reactions may have degraded in frozen storage but was renewed within several days after planting. Later in summer, qN rose to meet qP as midday light intensity increased.

Diurnal Profiles of Fluorescence Emissions

Diurnal CF profiles differed between cloudy and sunny days. For example, on cool cloudy days, when the incoming photosynthetically active radiation (PAR) did not exceed 200

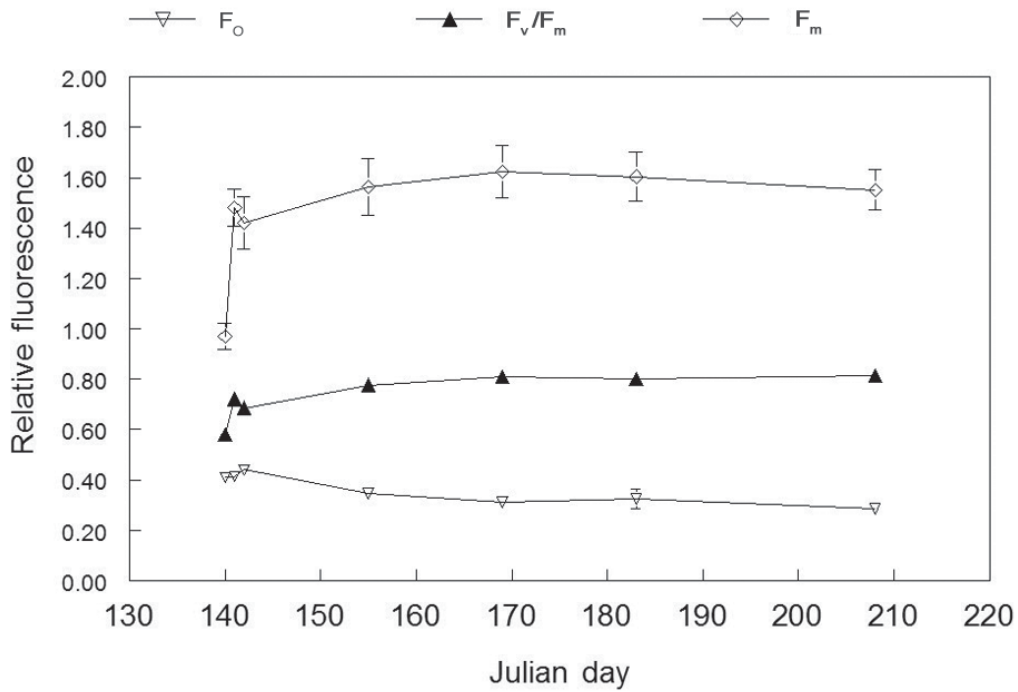

Figure 4— F_o , F_m , and F_v/F_m of 1-year-old Douglas-fir seedlings immediately after their removal from frozen storage and transplanting into a nursery bed (Julian Day 140). Each data point represents a mean ± 1 SE of nine seedlings.

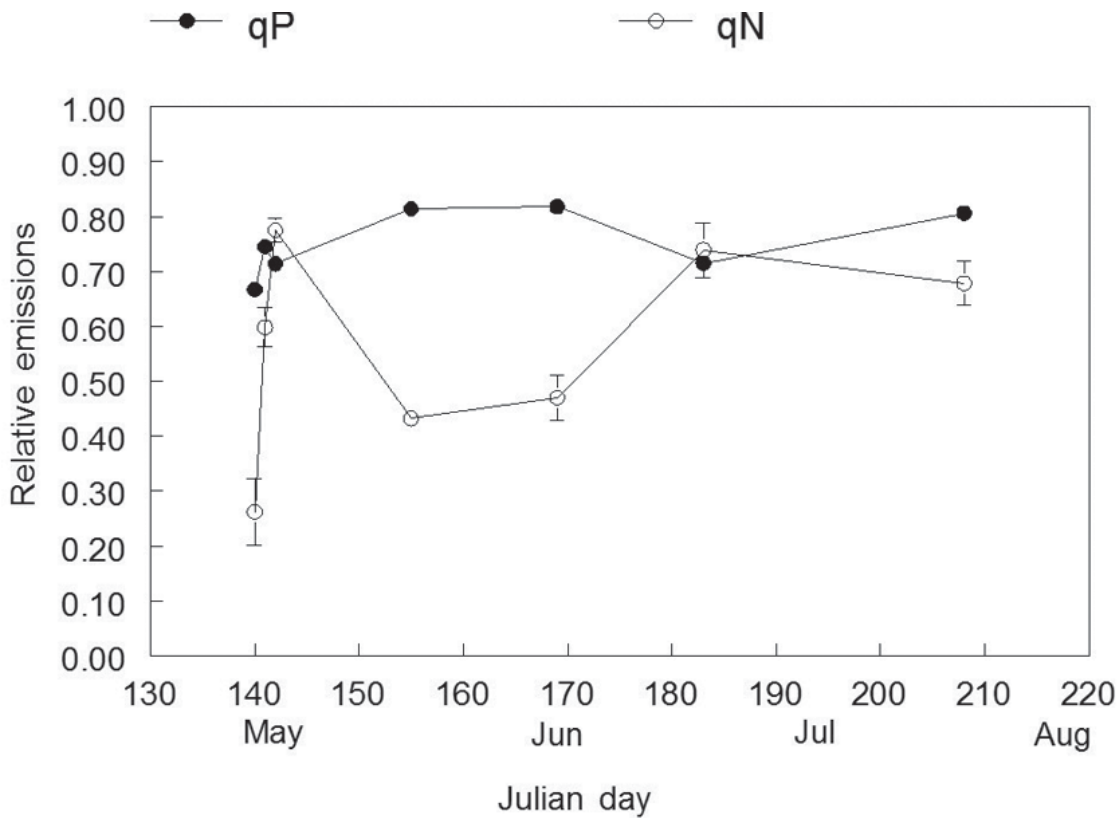

Figure 5—Quenching coefficients, qP and qN , from 1-year-old Douglas-fir seedlings immediately after their removal from frozen storage and transplanting into a nursery bed (Julian Day 140). Each data point represents a mean ± 1 SE of nine seedlings.

$\mu\text{mol}/\text{m}^2/\text{sec}$ (full sunlight is about $2,000 \mu\text{mol}/\text{m}^2/\text{sec}$), F_v/F_m and qP remained near 0.80 all day, while qN remained below 0.6 (figure 6). This suggests that at low light intensity, photochemical quenching was “using up” most of the incoming light energy, so the plant didn’t have to rely much on qN for energy dissipation. In contrast, on a bright sunny day (midday PAR = $1,800 \mu\text{mol}/\text{m}^2/\text{sec}$), while F_v/F_m and qP remained near 0.80, qN rose sharply, exceeding qP much of the day (figure 7). The interpretation here is that qP was saturated so that backup quenching was called upon to help dissipate the excess energy. Slight depressions in F_v/F_m and qP in late afternoon further indicate slight stress.

The quenching coefficients are very sensitive stress indicators (Lichtenthaler and Rinderle 1988); qP is a relatively fixed property, changing only slowly in response to light adaptation. On the other hand, qN is plastic, adjusting rapidly as stress increases or decreases. This illustrates the elegant sensitivity with which the seedlings were able to respond to rapid changes in light intensity on a short term basis.

Responses to Cold Weather—At the outset of this study, we had hoped for a winter arctic front that would appreciably affect the seedlings so that their response to such an event could be observed. Unfortunately (or fortunately), there was no such event during the very mild winter

of 1997 to 1998. Only one cold, snowy episode occurred during the week of January 7 to 15 (figure 8).

Temperatures began falling to below freezing on the night of January 9 and remained below freezing for four consecutive nights. Several inches of snow fell on January 10 to 11, blocking nearly all light from the seedlings. The snow melted and temperatures began to climb to 40°F (4°C) beginning January 13. Some key CF responses to this event are shown in context of the overall seasonal patterns in figure 9.

After the initial transplanting recovery phase, F_v/F_m remained near 0.80 throughout the year and did not show any response to the cold event; qP also remained high throughout the year. However, it exhibited a sharp, but temporary, drop to about 0.15 immediately following the cold event. In contrast, qN varied considerably, being relatively high during the sunny summer months and lower during fall, winter, and spring. During the cold event, as qP dropped, qN increased sharply.

The low temperatures that occurred during that cold event were not lethal to Douglas-fir seedlings at that time of year, which have LT_{10} and LT_{50} temperatures approximately -15°C (5°F) and -18°C (-0.4°F), respectively (Y. Tanaka, unpublished data). Therefore, no significant damage would be expected. With this in mind, the following interpretation is offered. The cold event (perhaps coupled

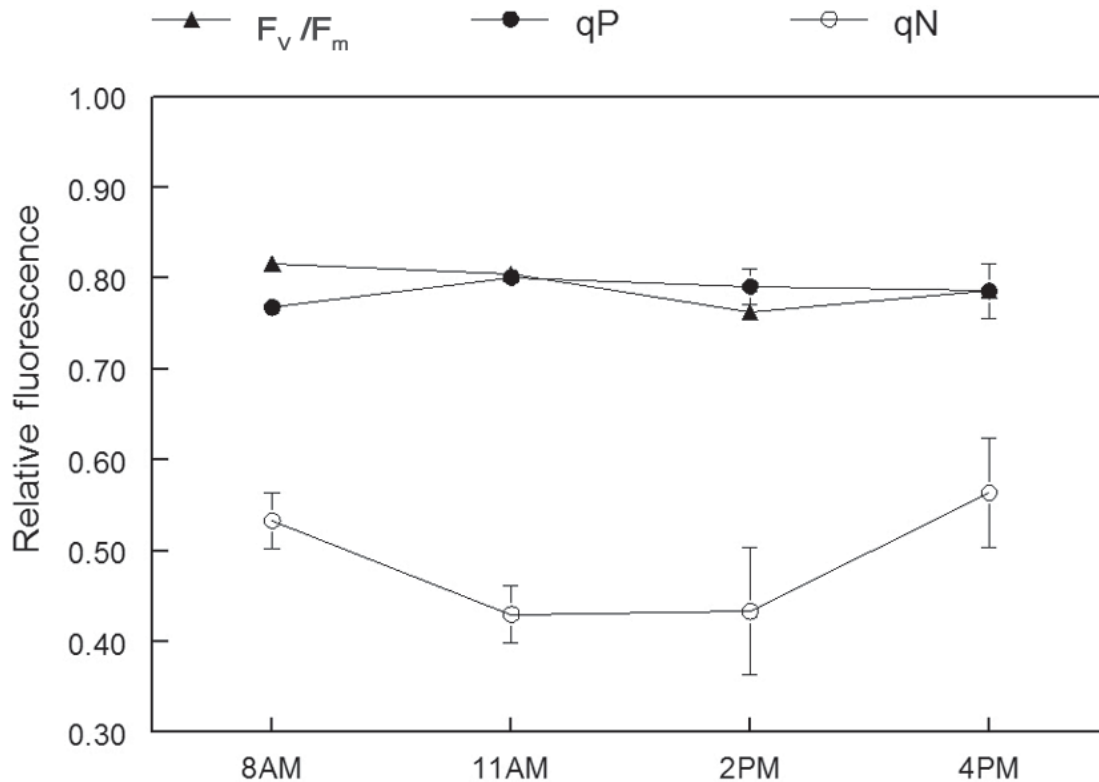

Figure 6—Diurnal trend of F_v/F_m , qP , and qN for 2-year-old Douglas-fir seedlings on a dark, cloudy day. Each data point represents a mean ± 1 SE of nine seedlings.

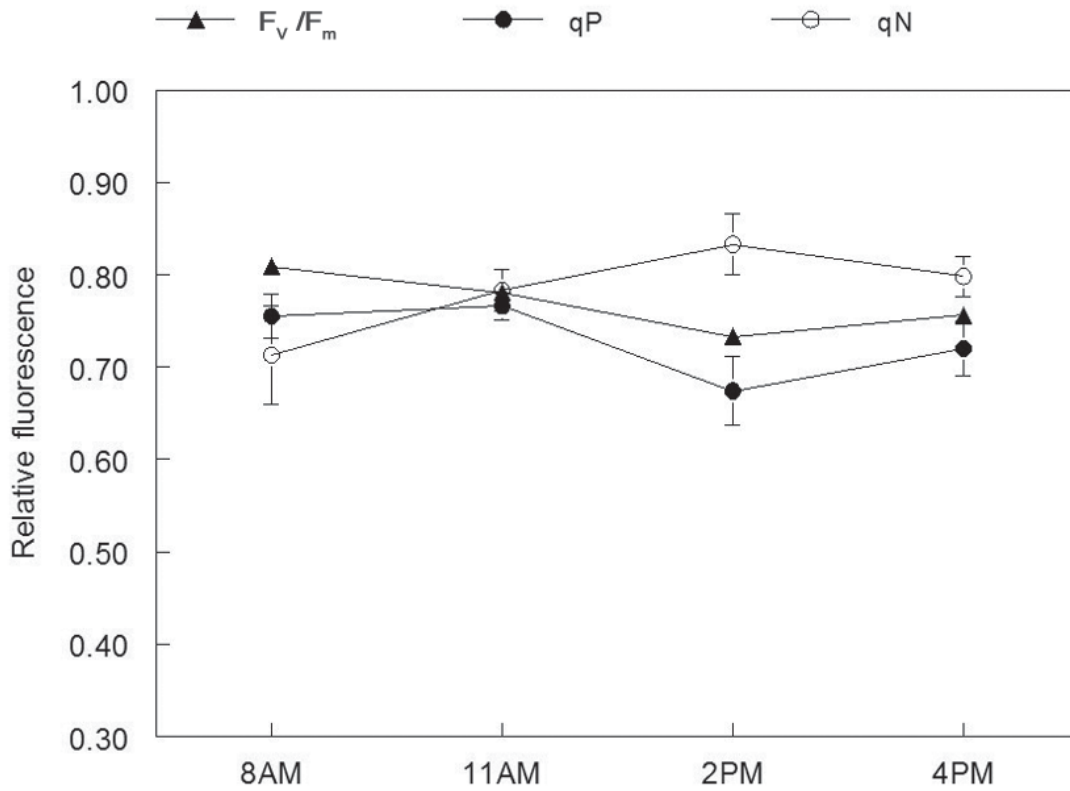

Figure 7—Diurnal trend of qP and qN for 2-year-old Douglas-fir seedlings on a bright, sunny day. Each data point represents a mean ± 1 SE of nine seedlings.

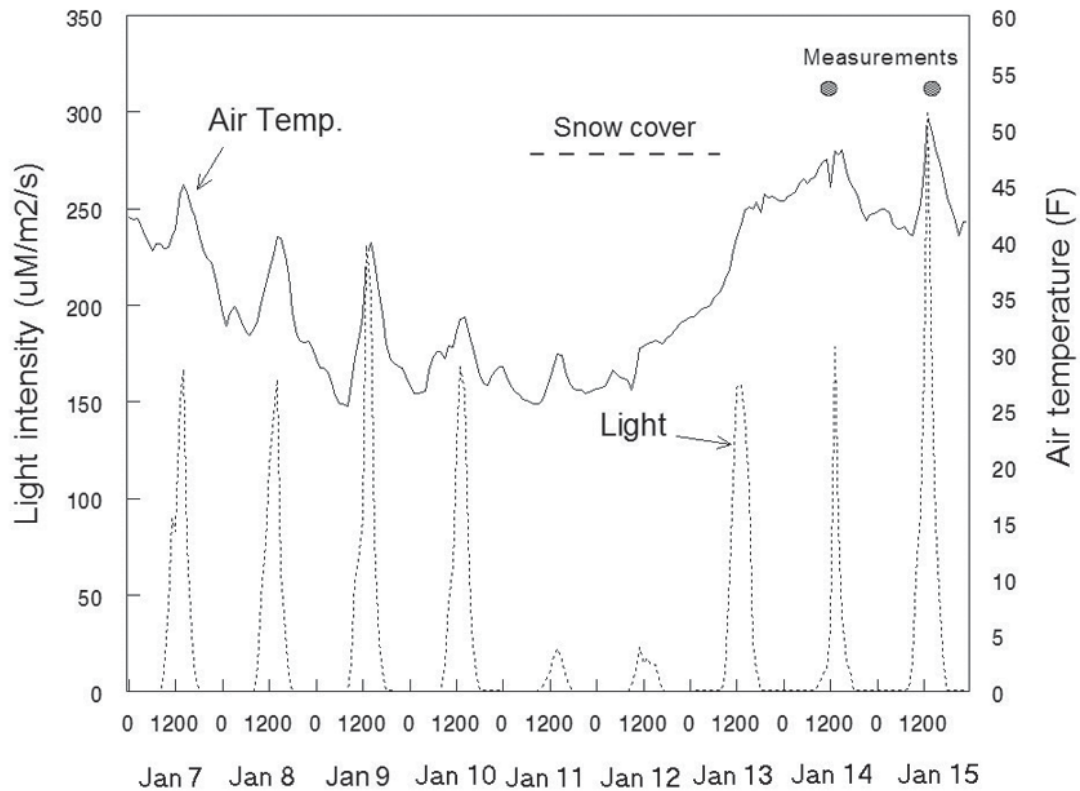

Figure 8—Record of air temperature, light intensity, and snow cover for a cold period in January 1998. Douglas-fir seedlings were covered with snow January 11 to 13. Large dots indicate times that CF emissions were measured on these seedlings.

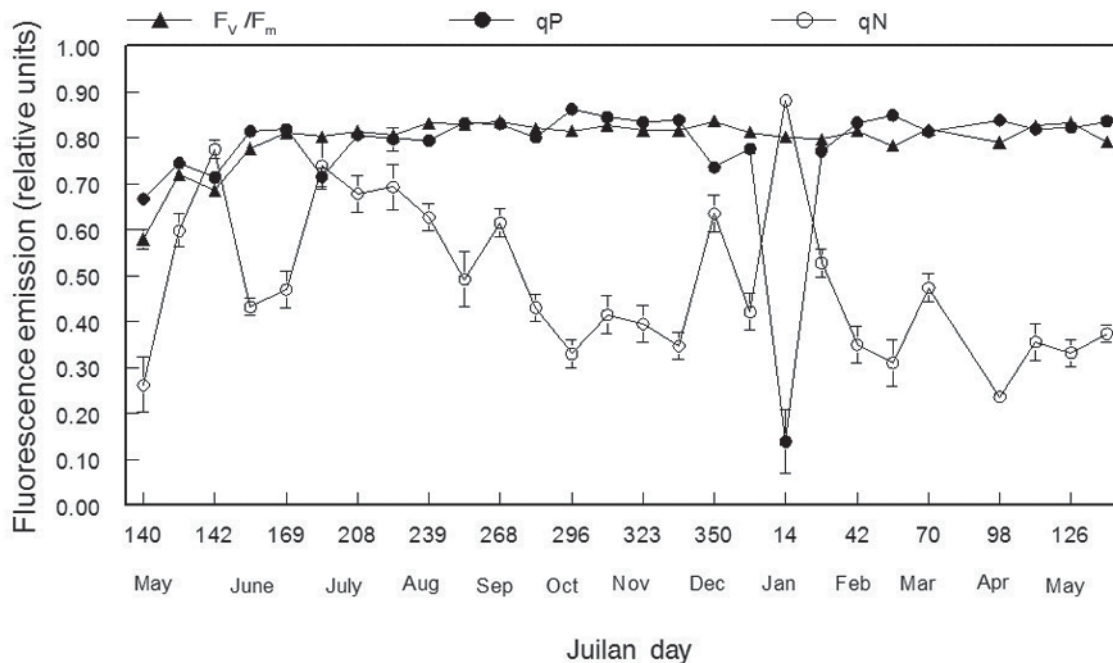

Figure 9—Seasonal trend of F_v/F_m , qP, and qN for Douglas-fir nursery seedlings showing changes in qP and qN immediately following a cold event in mid-January (see figure 8). Each data point represents a mean ± 1 SE of nine seedlings.

with 3 days of near darkness beneath snow) resulted in a slight and transient stress in the seedlings. Their response was manifest as a temporary disruption of qP that was compensated by a sharp increase in qN. This stress abated with a return to lighter, warmer conditions, and CF parameters returned rapidly to normal. An important point is that F_v/F_m did not respond to this event, indicating its robustness and stability.

Because of its robustness, F_v/F_m has often been used to quantify damage from severe freezing. An example of this comes from the work of Perks and others (2004). They subjected foliage of Douglas-fir seedlings to CF analysis following exposure to subfreezing temperatures while they were dehardening during February, early and late March, and April. At each test date, subfreezing temperatures depressed F_v/F_m from near 0.8 to below 0.4 (figure 10). As the seedlings continued to deharden, the F_v/F_m values became more depressed by low temperatures. For example, a temperature exposure of -20°C (-4°F) had no effect on F_v/F_m in February, but in late March the same temperature depressed F_v/F_m to 0.2. The authors propose, as have others, that F_v/F_m following freezing can provide a simple, rapid, and accurate prediction of cold tolerance.

Summary and Conclusions

Plants have evolved intricate mechanisms for dissipating, or quenching, the light energy they absorb. Some of this energy is used in photosynthesis (photochemical quenching, qP), while the remainder is dissipated by nonphotochemical (qN) or fluorescence (qF) quenching. Stress caused by high

and low temperature, disease, inadequate nutrition, and so on impairs a plant's ability to manage energy quenching. Thus, by measuring and interpreting the three components of quenching using chlorophyll fluorescence (CF), it is possible to detect damage resulting from subtle, transient stress as well as long term, severe stress. Three important CF parameters that are often reported in the nursery literature are qP, qN, and F_v/F_m .

qP has a normal range of between 0.7 and 0.8. Diurnal variability is low but seasonal variability can be moderate to high. qP often falls during or after stress events but can recover rapidly as damaged tissues and reactions are repaired by the plant.

qN has a much broader normal range, varying from about 0.3 to 0.7. Diurnal and seasonal variability are high, so qN is a very sensitive indicator of stress. Very slight stresses can cause relatively large changes in qN.

F_v/F_m (optimal quantum yield) has a normal range of 0.7 to 0.8, is seasonally and diurnally stable, and is therefore a robust seedling damage indicator. Only severe stress can cause a significant reduction in F_v/F_m . For this reason it is often used to detect severe cold damage. When this value falls below about 0.6 it may be cause for concern.

Damaged or stressed plants have the ability to recover quickly, so it is important to measure CF parameters over a course of several days following stressful events before conclusions about plant damage can be reached. If F_v/F_m remains low and qN high for several days, this indicates that significant damage to the photosynthetic system has probably occurred.

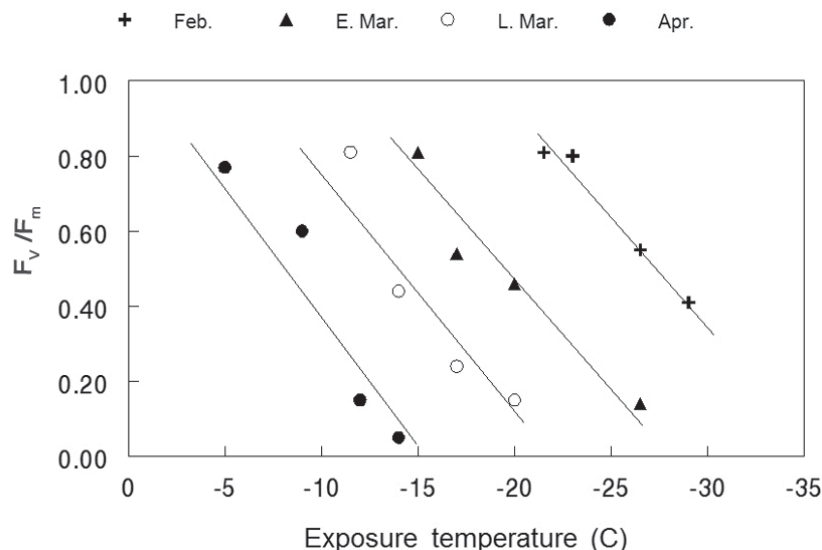

Figure 10— F_v/F_m values measured on Douglas-fir seedling needles following exposure to subfreezing temperatures during dehardening in February, early and late March, and April (modified from Perks and others 2004).

Acknowledgments

CF data collection was competently performed by Patty A Ward with assistance from James Keeley. Drs. Stephen Grossnickle and Thomas Landis reviewed the draft manuscript and offered many useful suggestions. I am indebted to Weyerhaeuser Company for use of formerly unpublished data.

References

- Adams GT, Perkins TD. 1993. Assessing cold tolerance in *Picea* using chlorophyll fluorescence. *Environmental and Experimental Botany* 33:377-382.
- Binder WD, Fielder P. 1996. Chlorophyll fluorescence as an indicator of frost hardiness in white spruce seedlings from different latitudes. *New Forests* 11:233-253.
- Demmig-Adams B, Adams WW III. 2000. Harvesting sunlight safely. *Nature* 403:371-374.
- Fisker SE, Rose R, Haase DL. 1995. Chlorophyll fluorescence as a measure of cold hardiness and freezing stress in 1+1 Douglas-fir seedlings. *Forest Science* 41:564-575.
- Genty B, Briantais J-M, Baker NR. 1989. The relationship between the quantum yield of photosynthetic electron transport and quenching of chlorophyll fluorescence. *Biochimica et Biophysica Acta* 990:87-92.
- Govindjee. 1995. Sixty-three years since Kautsky: Chlorophyll_a fluorescence. *Australian Journal of Plant Physiology* 22:131-160.
- Krause GH, Weis E. 1991. Chlorophyll fluorescence and photosynthesis: the basics. *Annual Review of Plant Physiology* 42:313-349.
- Lichtenthaler HK, Rinderle U. 1988. Chlorophyll fluorescence signatures as vitality indicators in forest decline research. In: Lichtenthaler HK, editor. *Applications of chlorophyll fluorescence*. Dordrecht (Netherlands): Kluwer Academic. p 143-149.
- Mohammed GH. 2005. Personal communication. Sault Ste Marie (ON): Ontario Forest Research Institute. Retired.
- Mohammed GH, Binder WD, Gilles SL. 1995. Chlorophyll fluorescence: a review of its practical forestry applications and instrumentation. *Scandinavian Journal of Forest Research* 10:383-410.
- Perks MP, Monaghan S, O'Reilly C, Mitchell DT. 2001. Chlorophyll fluorescence characteristics, performance and survival of freshly lifted and cold stored Douglas-fir seedlings. *Annals of Forest Science* 58:225-235.
- Perks MP, Osborne BA, Mitchell DT. 2004. Rapid predictions of cold tolerance in Douglas-fir seedlings using chlorophyll fluorescence after freezing. *New Forests* 28:49-62.
- Schreiber U, Bilger W, Neubauer C. 1995. Chlorophyll fluorescence as a noninvasive indicator for rapid assessment of *in vivo* photosynthesis. In: Schultze E-O, Caldwell MM, editors. *Eco-physiology of photosynthesis*. Berlin, Heidelberg, New York: Springer-Verlag. p 48-70.
- Strand M, Öquist G. 1988. Effects of frost hardening, dehardening and freezing stress on *in vivo* chlorophyll fluorescence of seedlings of Scots pine (*Pinus sylvestris* L.). *Plant, Cell and Environment* 11:231-238.
- Tanaka Y, Brotherton P, Hostetter S, Chapman D, Dyce S, Belanger J, Duke S. 1997. The operational planting stock testing program at Weyerhaeuser. *New Forests* 13:423-437.

Appendix 1A—Chlorophyll fluorescence (CF) emissions parameters yielded by a “Kautsky” fluorometer.

Parameter	Definition	Description
F_o	Original fluorescence	Fluorescence which emanates from the light-harvesting pigments of the leaf; generally considered a “background level” fluorescence which is zeroed out when measuring PSII chlorophyll fluorescence.
F_v	Variable fluorescence	Height of the fluorescence peak above F_o following exposure to the actinic light pulse.
F_t	Fluorescence at steady-state	Height of the fluorescence peak 5 minutes following the end of the light pulse.
F_m	Maximal fluorescence	$F_v + F_o$
F_v/F_m	Optimal quantum yield	An estimate of the ratio of moles of carbon fixed per mole of light energy absorbed (Genty and others 1989); theoretical maximum value for C_3 photosynthesis is approximately 0.830.

Appendix 1B—Additional CF emissions parameters yielded by a PAM fluorometer.

Parameter	Definition	Description
qP	Photochemical quenching	Absorbed light energy that is dissipated (quenched) through electron flow in the light reaction).
qN	Nonphotochemical quenching	Absorbed light energy that is dissipated largely through sensible heat loss and other non-photochemical mechanisms.
Y	Effective quantum yield	The actual quantum yield at a point in time; Y is generally much lower than the optimal quantum yield.
ETR	Electron transport rate	Empirical estimate of the rate of flow of electrons through the electron flow pathway.